

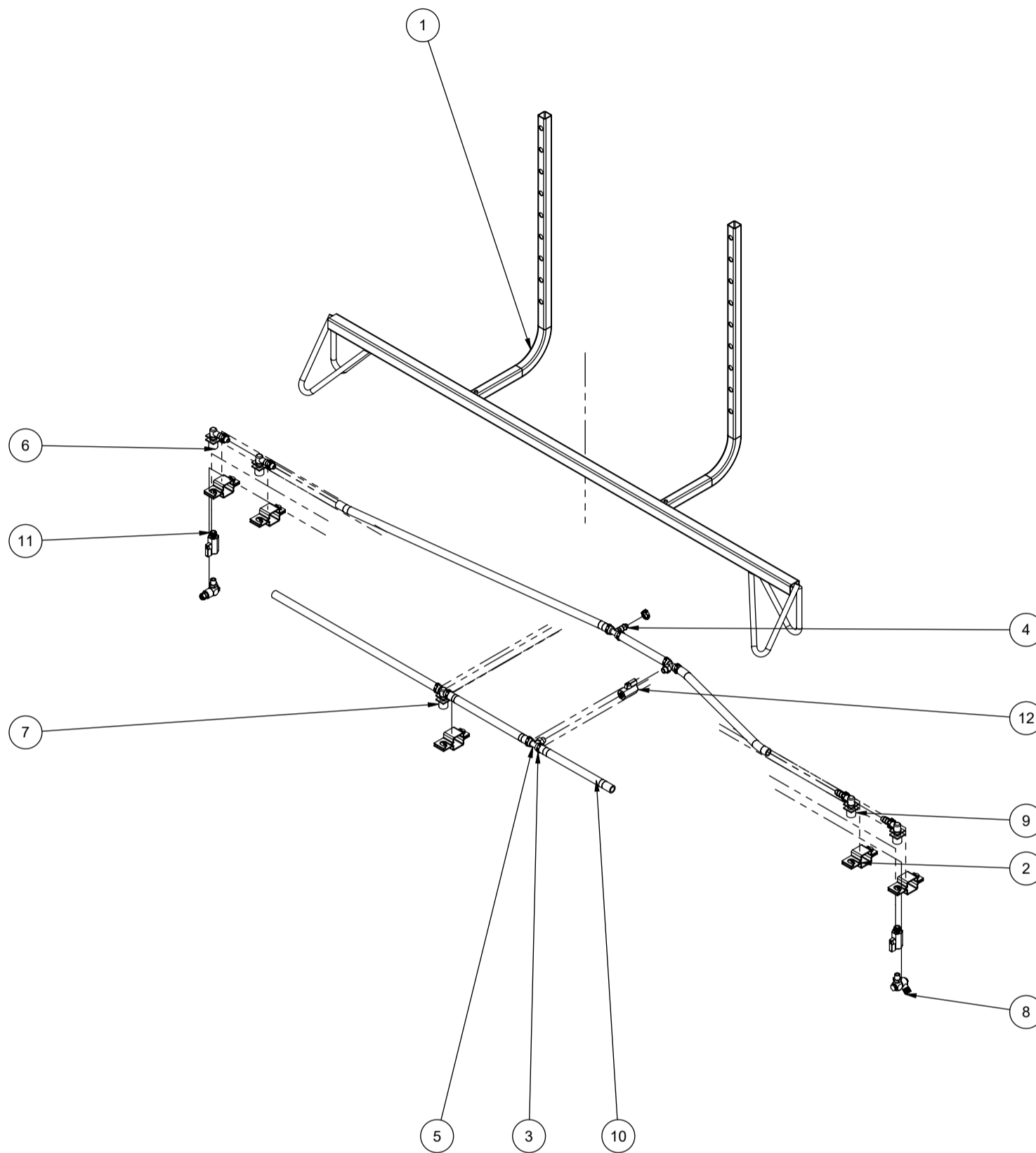

Part No. : I-06265  
Description : Versatile Boom 1.2 metre - Sub Kit  
Version : AV2  
Drawn by : JM

Drawn Date : 10/11/2020  
Approved Date : 07/06/2021  
Checked by : JP  
Approved by : JH/ BO



ITEM NO.	PartNo	DESCRIPTION	QTY.	Unit of Measure	REVISION
1	I-04742	Frame, Boom Spray, 1250x671x 298mm, 1.2m, Gal	1	EA	AV2
2	I-11561	Clamp, Kit, 1" Mounting for Nozzle Holders (Tecomec)	5	EA	STD
3	I-05453	Clamp, 1 Ear, 19.8mm, Stainless Steel	13	EA	STD
4	I-00706	Poly Tee 10mm Barb 3 Sides	1	EA	STD
5	I-00707	Tee, 2 Way, 10mm Barb 2 Sides - 3/8" BSP, PP	2	EA	STD
6	I-11584	Nozzle holder elbow (1 way) w/ 10mm barb	2	EA	STD
7	I-01250	Tee, 2 Way, Nozzle holder x 10mm Barb, PP	1	EA	STD
8	I-01252	Swivel, Nozzle Holder, 3/8" BSPM x 1/2" BSPM Swing, Nickel x PP	2	EA	STD
9	I-01249	Nozzle Holder with 1/4_ BSP Thread	2	EA	STD
10	I-00668	10mm spray hose /metre (working pressure)	5.0	MTR	STD
11	I-01178	Valve, Ball, MF, 1/4" , BSP, Mini, Nickle plated	2	EA	STD
12	I-01179	Valve, Ball, FF, 3/8" , BSP, Mini, Nickle plated	1	EA	STD

Part No. : I-06265  
 Description : Versatile Boom 1.2 metre - Sub Kit  
 Version : AV2  
 Drawn by : JM

Drawn Date : 10/11/2020  
 Approved Date : 07/06/2021  
 Checked by : JP  
 Approved by : JH/ BO

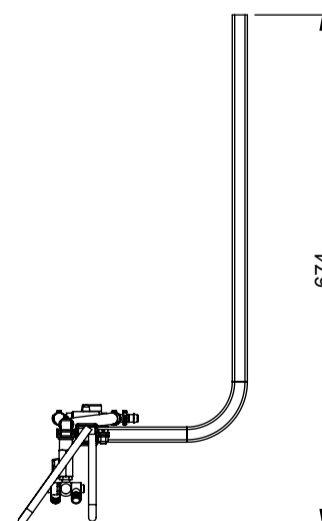
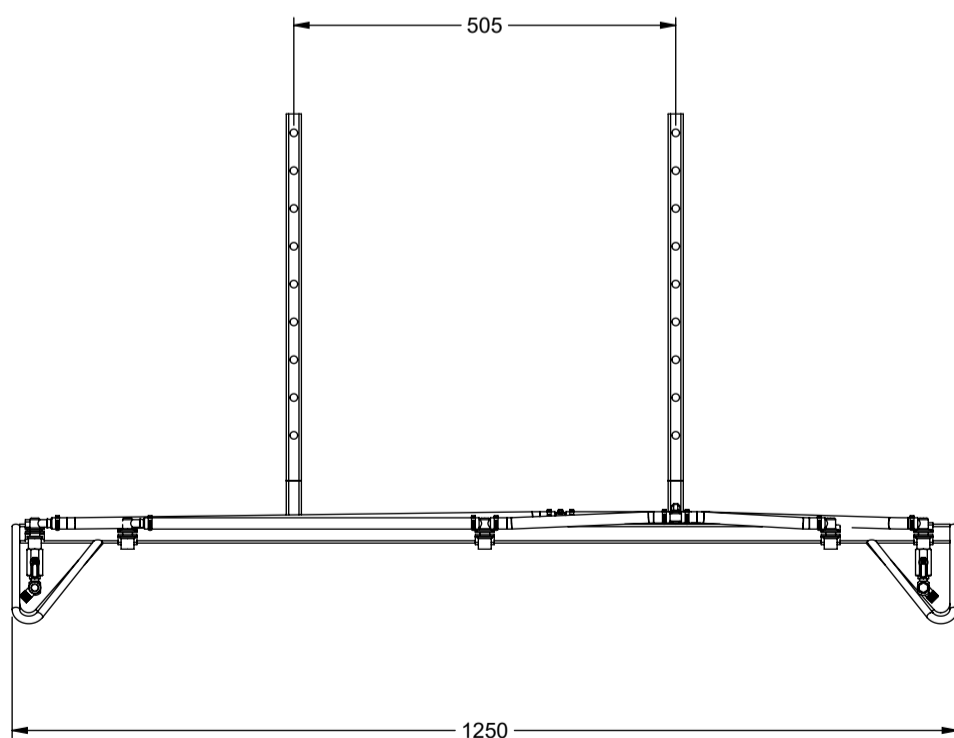
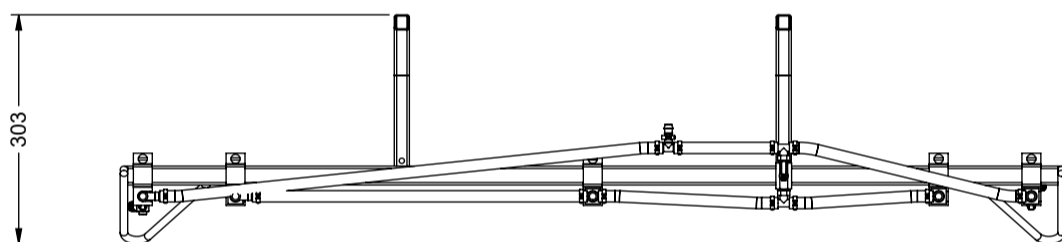
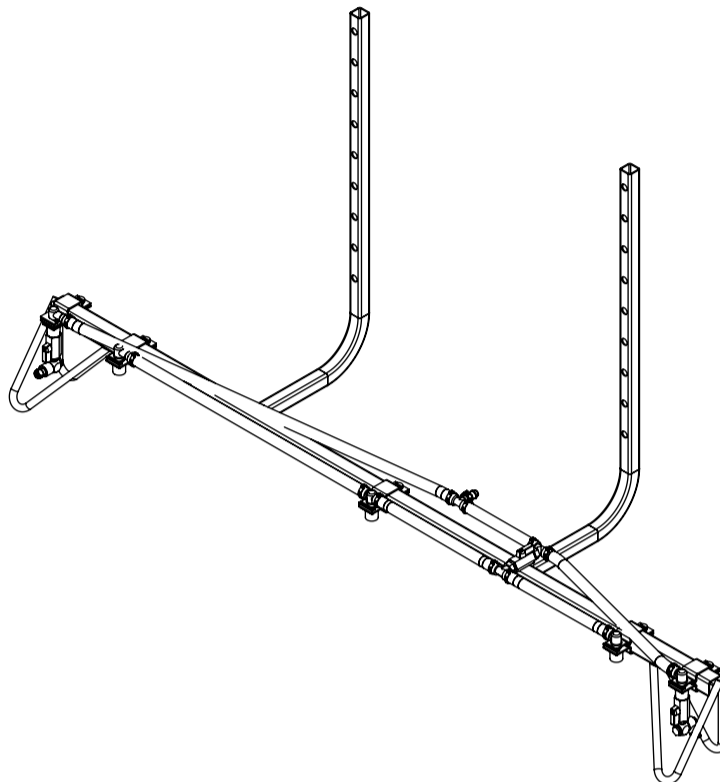













Part No. : I-06265  
Description : Versatile Boom 1.2 metre - Sub Kit  
Version : AV2  
Drawn by : JM

Drawn Date : 10/11/2020  
Approved Date : 07/06/2021  
Checked by : JP  
Approved by : JH/ BO



**AUSTRALIA'S #1 AUTHORITY IN LIQUID TRANSPORT PRODUCTS**

Document Preview	PartNo	Description	Qty	Unit of Measure	Revision
	I-04742	Frame, Boom Spray, 1250x671x 298mm, 1.2m, Gal	1	EA	AV2
	I-11561	Clamp, Kit, 1" Mounting for Nozzle Holders (Tecomec)	5	EA	STD
	I-05453	Clamp, 1 Ear, 19.8mm, Stainless Steel	13	EA	STD
	I-00706	Poly Tee 10mm Barb 3 Sides	1	EA	STD
	I-00707	Tee, 2 Way, 10mm Barb 2 Sides - 3/8" BSP, PP	2	EA	STD
	I-01249	Nozzle holder elbow (1 way) w/ 10mm barb	2	EA	STD
	I-01250	Tee, 2 Way, Nozzle holder x 10mm Barb, PP	1	EA	STD
	I-01252	Swivel, Nozzle Holder, 3/8" BSPM x 1/2" BSPM Swing, Nickel x PP	1	EA	STD
	I-01252	Swivel, Nozzle Holder, 3/8" BSPM x 1/2" BSPM Swing, Nickel x PP	1	EA	STD
	I-00696	Nozzle Holder with 1/4_ BSP Thread	2	EA	STD
	I-00668	10mm spray hose /metre (working pressure)	5	MTR	STD
	I-01178	Valve, Ball, MF, 1/4" , BSP, Mini, Nickle plated	2	EA	STD
	I-01179	Valve, Ball, FF, 3/8" , BSP, Mini, Nickle plated	1	EA	STD

Part No. : I-06265  
 Description : Versatile Boom 1.2 metre - Sub Kit  
 Version : AV2  
 Drawn by : JM

Drawn Date : 10/11/2020  
 Approved Date : 07/06/2021  
 Checked by : JP  
 Approved by : JH/ BO