

Description

Pressure regulating unloader valve, automatically relieves pressure from pump at shut-off.

With adjustable detergent injector.

INLET, OUTLET, BY-PASS: 3/8" G (M)

For XM, RR, JK, RK, RW series



Details	Value
Category	Accessories
Series	Regulating Valves - Valvole di regolazione
Versioning	3/A + IDR
ARCode	20396
Output (lt/min)	11

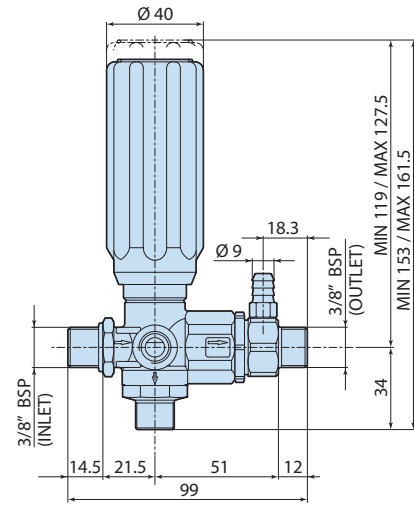
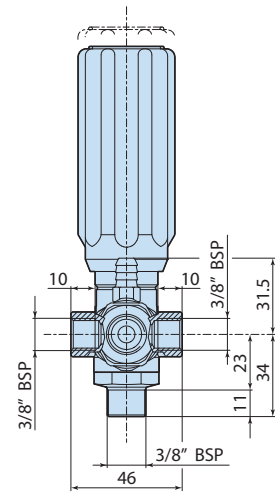

1568504